

product line **EXTRA**

# CAROUSEL



## PRODUCT COMPOSITION

SBR+EPDM rubber granules, aliphatic PU binder, vandal-resistant fiberglass shell, stainless steel railings, metal parts

## COLOR COMBINATION

standard: green, blue, yellow, orange  
(other combination on request)

## COLOR STABILITY

UV stable

## RECOMMENDED SAFETY SURFACE

safety rubber surface in the area of 2000 mm around the product (according to EN1177)

## PRODUCT SAFETY

certified according to EN1176  
complies with ASTM F1487 and CAN/CSA Z614

## INSTALLATION

the product is installed onto a concrete foundation

## PACKAGING





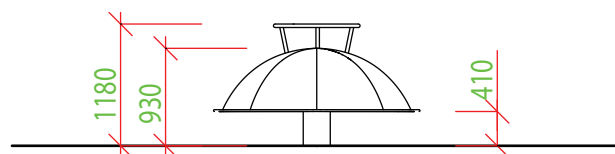
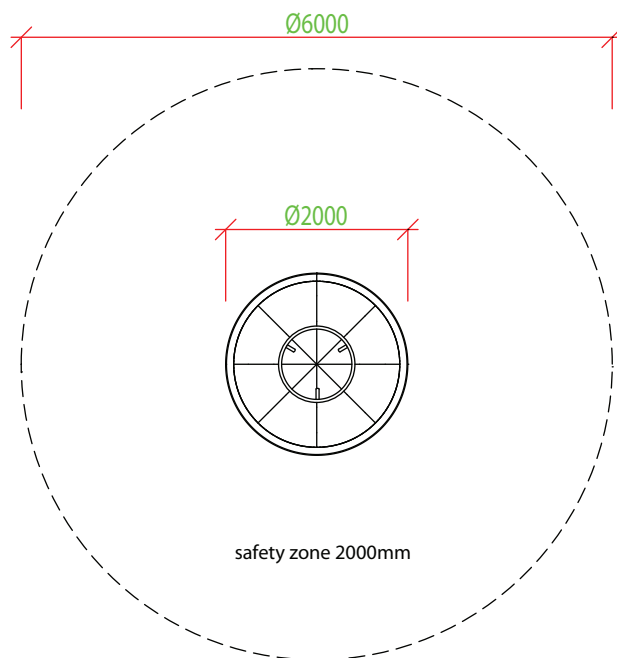

wrapped in plastic and delivered on a pallet 2100 x 2100mm

## STORAGE

in original packaging on a pallet  
in temperatures between - 40° C and 50° C



Our products are handmade, please allow dimensional tolerance up to 40 mm

 <b>185 kg</b> weight	 <b>1180 mm</b> critical fall height	 <b>2 h</b> assembly time	 <b>4 - 14 yrs</b> users' age	 <b>3</b> max. number of users	 <b>Ø 2000 mm</b> <b>h=1180 mm</b>
--	--	---	---	--	--

## 3D PROGRAM, s.r.o.

Objízdná 1911  
765 02 Otrokovice  
Czech Republic



MADE IN EU

www.3dprogram.eu  
info@3dprogram.eu  
+420 602 500 045 +420 577 700 718

